

! INFO !

- (DE) Die Batterie des Zugfahrzeugs bzw. gezogenen Fahrzeugs nicht direkt über die Steckdose aufladen.
- (FR) Ne pas charger les batteries du véhicule tracteur et/ou tracté directement sur la prise de courant.
- (NL) De accu van het trekkend voertuig c.q. getrokken voertuig niet rechtstreeks via de contactdoos opladen.
- (GB) Do not charge the battery of the towing vehicle and/or towed vehicle directly via the socket.
- (ES) No recargue la batería del vehículo remolque y/o del remolcado directamente mediante el enchufe.
- (IT) Non caricare la batteria del veicolo trainante o di quello trainato direttamente dalla presa.
- (SE) Ladda inte batteriet i det bogserande fordonet och/eller det bogserade fordonet direkt via kontakten.
- (CZ) Nenabíjajte baterii tažného ani taženého vozidla přes zásuvku.
- (DK) Oplad ikke bugseringskøretøjet og/eller det bugserede køretøjs batteri direkte v.h.a. stikdåsen.
- (FI) Älä lataa hinaavan ajoneuvon ja/tai hinattavan ajoneuvon akkuja suoraan pistorasian kautta.
- (GR) Μη φορτίζετε την μπαταρία του ρυμουλκούμενου οχήματος και/ή ρυμουλκημένου οχήματος απευθείας μέσω του ρευματοδότη.
- (NO) Batteriet til kjøretøyet som trekker eller blir trukket skal ikke lades direkte via koblingsboksen.
- (PL) Nie ładować akumulatora pojazdu holującego/holowanego bezpośrednio przez gniazdo.

- (DE) Gebrauchsanleitung
(FR) Mode d'emploi
(NL) Gebruikershandleiding
(GB) User guide
(ES) Guía del usuario
(IT) Manuale di istruzioni
(SE) Bruksanvisning
(CZ) Uživatelská příručka
(DK) Brugervejledning
(FI) Käyttöohjeet
(GR) Οδηγός χρήστη
(NO) Brukerveiledning
(PL) Instrukcja obsługi

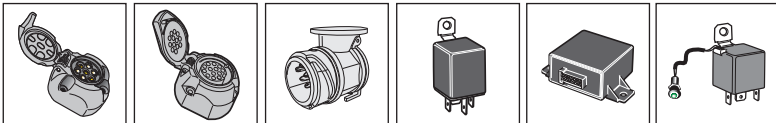
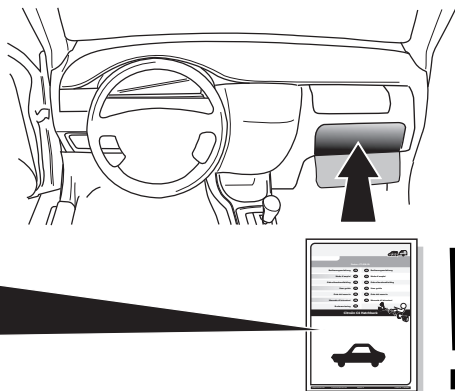

SPARE PARTS

www.ecs-electronics.com

ECS

ELECTRONICS



Partnr.: HY-053-DH

Gebrauchsanleitung (DE)

(CZ) Uživatelská příručka

Mode d'emploi (FR)

(DK) Brugervejledning

Gebruikershandleiding (NL)

(FI) Käyttöohjeet

User guide (GB)

(GR) Οδηγός χρήστη

Guía del usuario (ES)

(NO) Brukerveiledning

Manuale di istruzioni (IT)

(PL) Instrukcja obsługi

Bruksanvisning (SE)

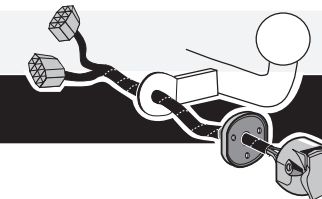

Hyundai iX55 2008-

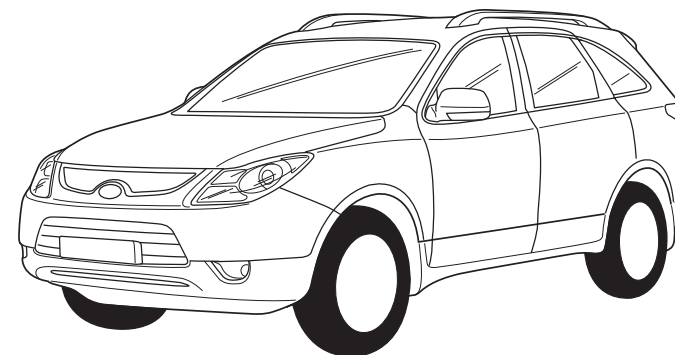

- (DE) Anschluss Steckdose (ES) Conexión de la caja de enchufe (CZ) Objímkový konektor (GR) Υποδοχή σύνδεσης
 (FR) Connection de la prise (IT) Allaccio zoccolo (DK) Stikdåse forbindelse (NO) Tilkobling koblingsboks
 (NL) Contactdoos aansluiting (SE) Anslutning kontaktdosa (FI) Pistorasia liitäntä (PL) Połączenie przez gniazdo
 (GB) Socket connection

| DIN/ISO 11446 | 1/L | 2 | 3/31 | 4/R | 5/58-R | 6/54 | 7/58-L | 8 | 9 | 10 | 11 | 12 | 13 |
|---------------|-----------|-----------|-----------|---------|---------|---------------------------------|---------|------------------|-------------------|---------------------------------|------------|---------------------|------------|
| Pmax | 21W | 2x21W | 21W | 21W | 52W | 3x21W | 52W | 2x21W | 180W/15Amp | 180W/15Amp | 180W/15Amp | 180W/15Amp | 180W/15Amp |
| (DE) | Blau | Blaue | Weiß | Grün | Braun | Rot (1,00mm ²) | Schwarz | Schwarz/ Rot | Braun/ Weiß | Rot (2,50mm ²) | Weiß | Rot/ Blau | Weiß |
| (FR) | Bleue | Bleue | Blanc | Vert | Marron | Rouge (1,00mm ²) | Noir | Noir/ Rouge | Marron/ Blanc | Rouge (2,50mm ²) | Blanc | Rouge/ Bleu | Blanc |
| (NL) | Blauw | Blauw | Wit | Groen | Bruin | Rood (1,00mm ²) | Zwart | Zwart/ Rood | Bruin/ Wit | Rood (2,50mm ²) | Wit | Rood/ Blauw | Wit |
| (GB) | Blue | Blue | White | Green | Brown | Red (1,00mm ²) | Black | Black/ Red | Brown/ White | Red (2,50mm ²) | White | Red/ Blue | White |
| (ES) | Azul | Azul | Bianco | Verde | Marrón | Rojo (1,00mm ²) | Negro | Negro/ Rojo | Marrón/ Blanco | Rojo (2,50mm ²) | Blanco | Rojo/ Azul | Blanco |
| (IT) | Giallo | Blu | Bianco | Verde | Marrone | Rosso (1,00mm ²) | Nero | Nero/ Rosso | Marrone/ Bianco | Rosso (2,50mm ²) | Bianco | Rosso/ Blu | Bianco |
| (SE) | Gul | Blä | Vit | Grön | Brun | Röd (1,00mm ²) | Svart | Svart/ Röd | Brun/ Vit | Röd (2,50mm ²) | Vit | Röd/ Blå | Vit |
| (CZ) | Žlutá | Modrá | Bílá | Zelená | Hnědá | Červená (1,00mm ²) | Černá | Černo/ Červená | Hnědo/ Bílá | Červená (2,50mm ²) | Bílá | Červenó/ Modrá | Bílá |
| (DK) | Gul | Blä | Hvid | Grøn | Brun | Rød (1,00mm ²) | Sort | Sort/ Rød | Brun/ Hvid | Rød (2,50mm ²) | Hvid | Red/ Blå | Hvid |
| (FI) | Keltainen | Sininen | Valkoinen | Vihreä | Ruskea | Punainen (1,00mm ²) | Musta | Musta/ Punainen | Ruskea/ Valkoinen | Punainen (2,50mm ²) | Valkoinen | Punainen/ Sininen | Valkoinen |
| (GR) | Κίτρινο | Μπλε | Λευκό | Πράσινο | Καφέ | Κόκκινο (1,00mm ²) | Μαύο | Μαύο/ Κόκκινο | Καφέ/ Λευκό | Κόκκινο (2,50mm ²) | Λευκό | Κόκκινο/ Μπλε | Λευκό |
| (NO) | Gul | Blä | Hvit | Grønn | Brun | Rød (1,00mm ²) | Svart | Svart/ Rød | Brun/ Hvit | Rød (2,50mm ²) | Hvit | Red/ Blå | Hvit |
| (PL) | Żółty | Niebieski | Biały | Zielony | Brazowy | Czerwony (1,00mm ²) | Czarny | Czarny/ Czerwony | Brazowy/ Biały | Czerwony (2,50mm ²) | Biały | Czerwony/ Niebieski | Biały |

- (DE) Sicherungen austauschen (ES) Cambio de fusible (CZ) Výměna pojistky (GR) Αλλαγή ασφάλειας
 (FR) Remplacer les fusibles (IT) Sostituire i fusibili (DK) Udskiftning af sikringer (NO) Skifte sikringene
 (NL) Zekeringen vervangen (SE) Byte av säkringar (FI) Vaihtaa varokkeet (PL) Wymienić bezpieczniki
 (GB) Changing the fuse

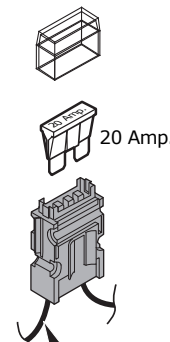
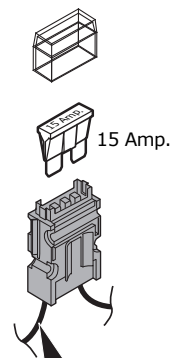
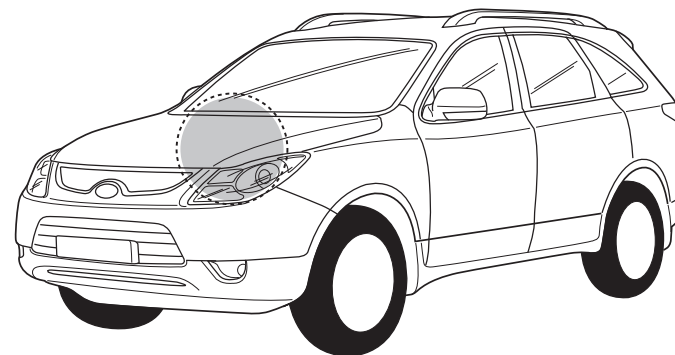

- (DE) Braun/Weiß (DK) Brun/Hvid
 (FR) Marron/Blanc (FI) Ruskea/Valkoinen
 (NL) Bruin/Wit (GR) Καφέ/Λευκό
 (GB) Brown/White (NO) Brun/Hvit
 (ES) Marrón/Blanco (PL) Brazowy/Biały
 (IT) Marrone/Bianco
 (SE) Brun/Vit
 (CZ) Hnědo/Bílá



- (DE) Orange (DK) Orange
 (FR) Orange (FI) Oranssi
 (NL) Oranje (GR) Πορτοκάλι
 (GB) Orange (NO) Oransje
 (ES) Naranja (PL) Pomarańczowy
 (IT) Arancione
 (SE) Orange
 (CZ) Oranžová

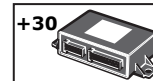

INFO : Storage

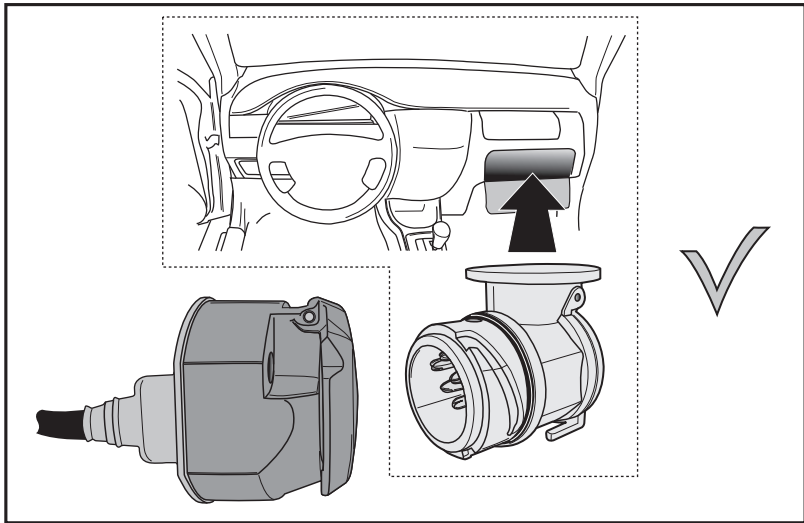
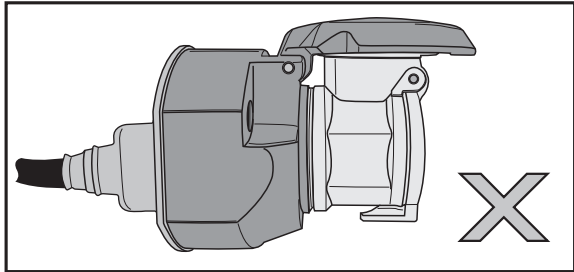
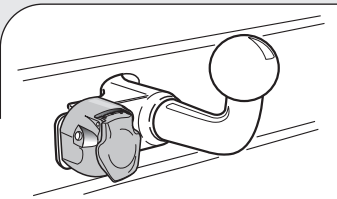
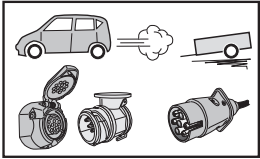

INFO

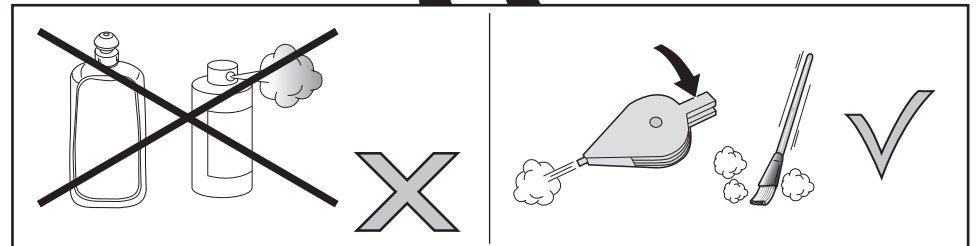
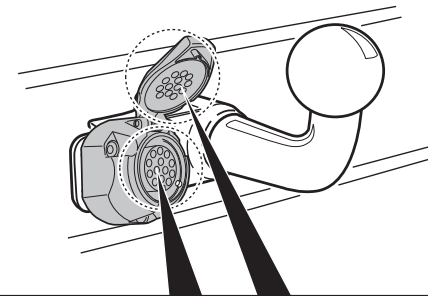
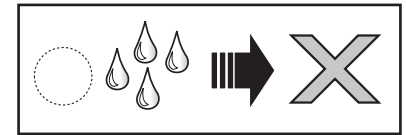
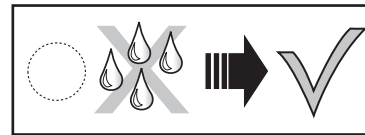
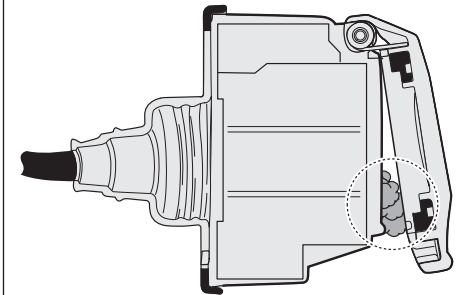
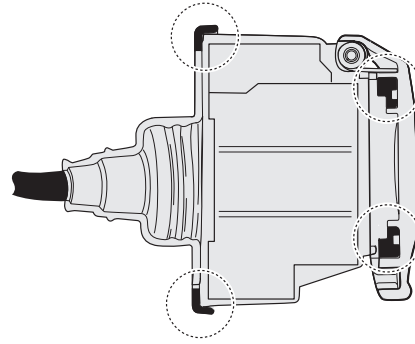
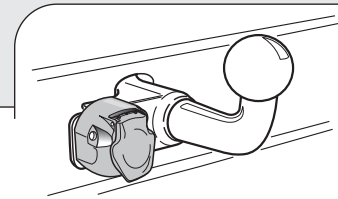
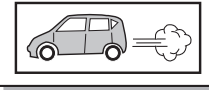

INFO : Ring.

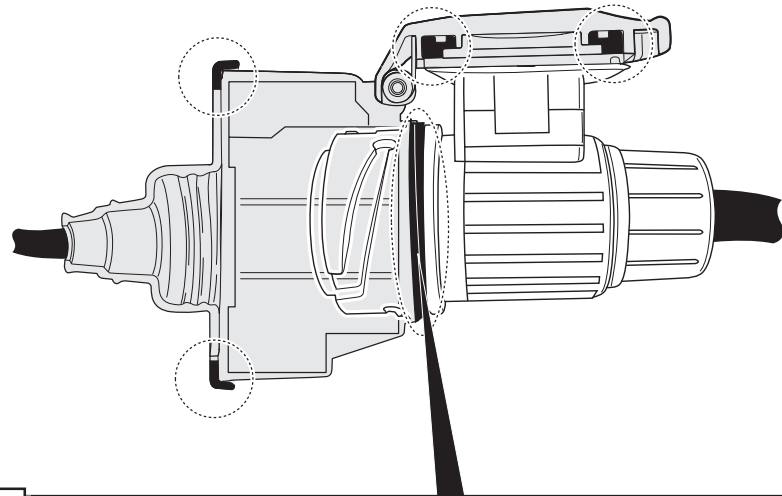
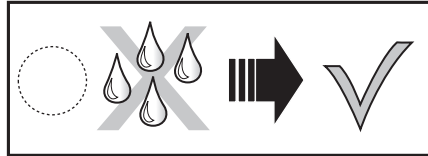
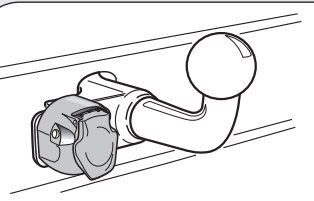
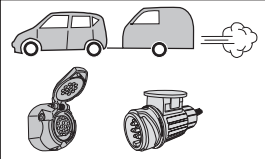

INFO

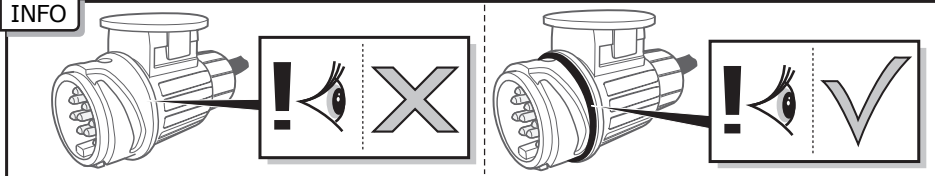

INFO : Adapt.

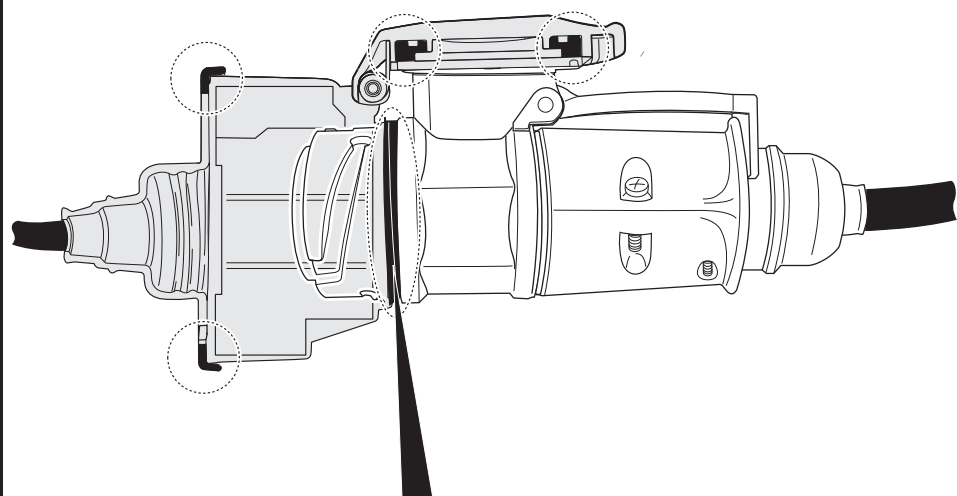
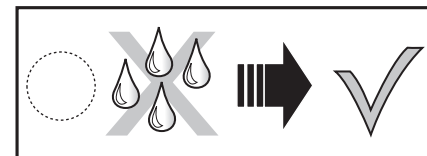
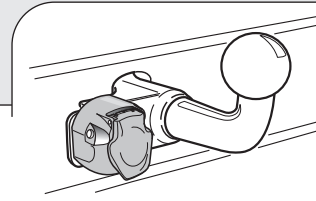
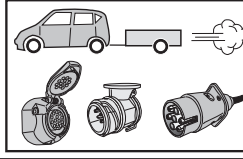

INFO

